

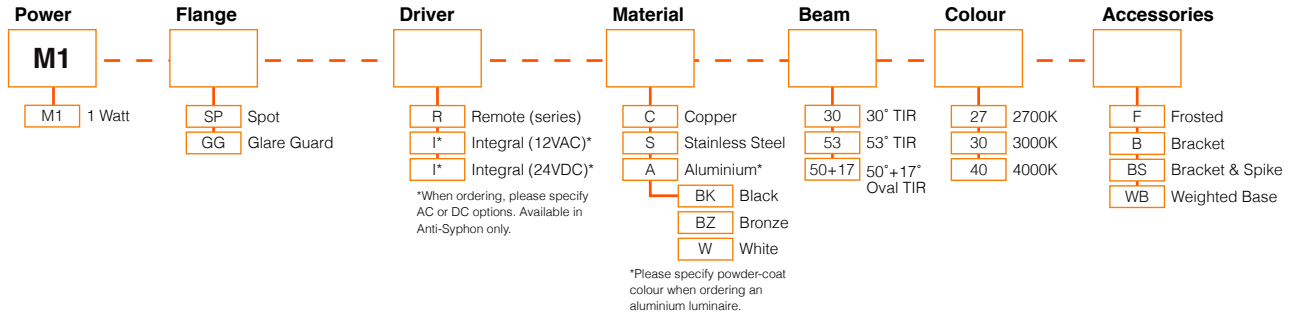

## M1 SPOT LIGHTS CONFIGURATION

Please fill in appropriate codes into boxes provided



## SPECIFICATIONS

<b>Power</b>	1 Watt
<b>Ingress Protection Rating</b>	IP68
<b>Cable</b>	H05RN-F 2x 0.75mm
<b>Material</b>	-Black/White/Bronze Powdercoated Aluminium -Natural Copper -316 Stainless Steel
<b>Removable Light Engine</b>	Pin Mounted 1W Cree XPG-3 Chip
<b>Colour Temperature</b>	Warm White - 2700K and 3000K Neutral White - 4000k
<b>Optic Degrees</b>	15°TIR, 30°TIR, 53°TIR, 50+17°TIR
<b>Lens Cover</b>	Clear, Frosted
<b>CRI</b>	90+ CRI
<b>Efficacy</b>	80lm/w - Delivered from Luminaire with unobstructed beam
<b>Input</b>	350mA Constant current (Remote) 12V AC (Integral) 24V DC (Integral)
<b>Warranty</b>	Electronics Warranty 5 Years
<b>Body Warranty</b>	5 years Aluminium and 10 years Copper and Stainless Steel
<b>LED Shield</b>	LED Bypass Shunt Reverse polarity protection
<b>LED Life Expectancy</b>	50,000 Hours

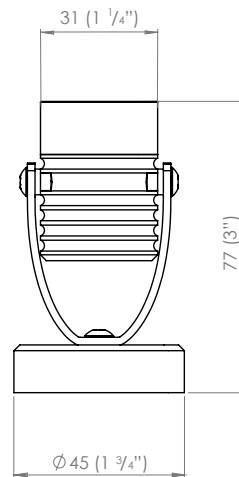

MODUX ONE BRACKET & SPIKE

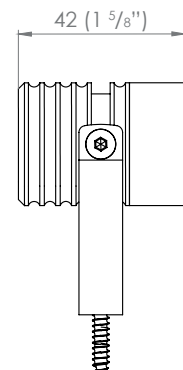
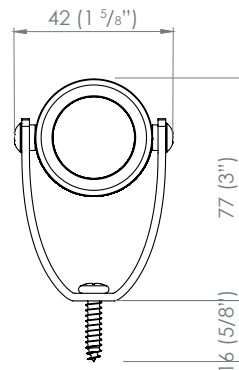
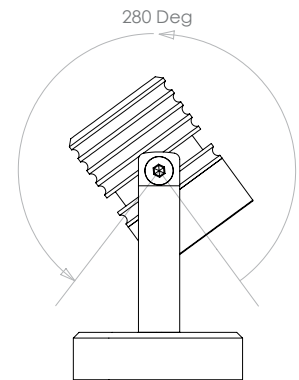

## M1 SPOTLIGHTS

The M1 luminaire range is powered by a 1 watt LuxR light engine that offers a wide choice of LED colours. The luminaire was developed to meet the challenge of delivering high quality practical accent lighting with maximum energy efficiency and a long, maintenance-free life.

All LuxR luminaires offer a replaceable LED system using Cree LED chips for maximum performance and long life. Precise LED binning by Cree ensure the same colour temperature across all our luminaires which allows LuxR products to be situated close to one another without the fear of colour variance in the colours.

This luminaire is extremely tough, durable and waterproof, making it ideal for installation in public spaces, large-scale projects and residential areas.

## REPLACING COMPONENTS

Unscrew the flange paying close attention to the assembly order or refer to the diagram below. Locate the item that needs to be replaced. It is imperative you replace the component with factory LuxR parts to ensure correct operation of the luminaire. When reassembling make sure all the components are in their correct order to ensure water tightness and correct light output.

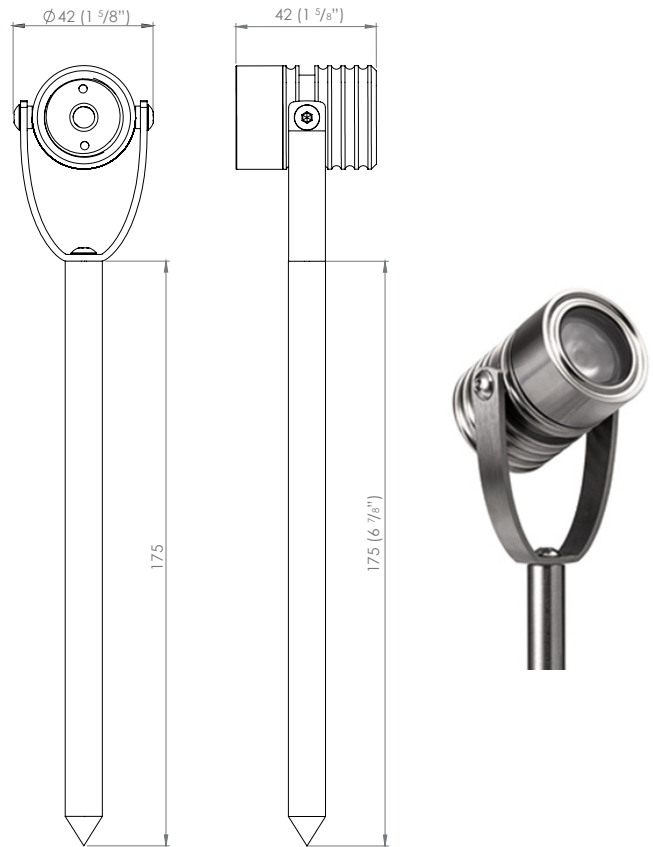
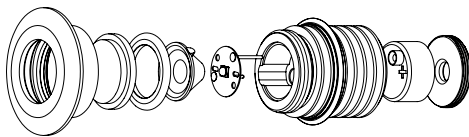

## BEAM ANGLES

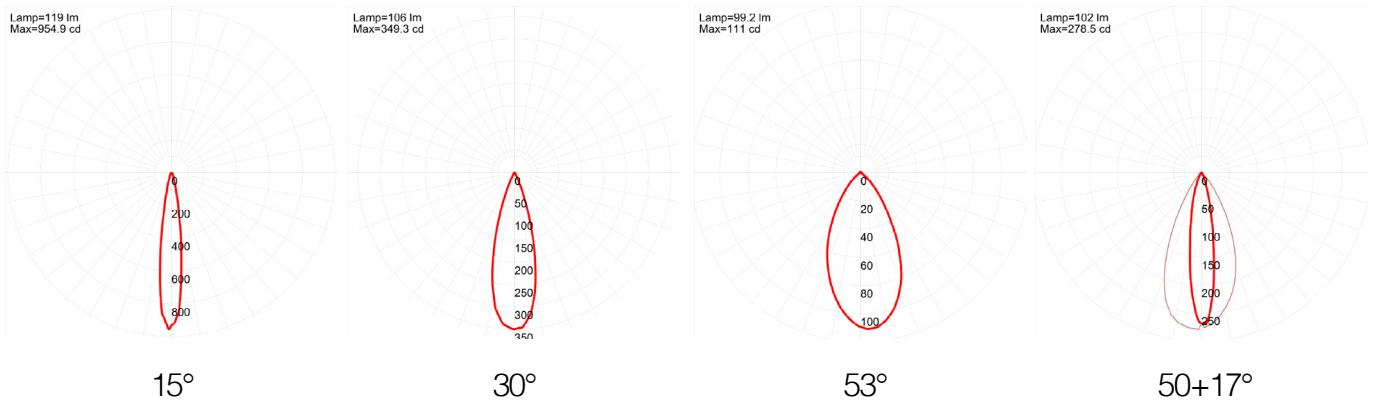

## REMOTE DRIVER WIRED IN SERIES

Often referred to as series wiring the current in a series circuit follows one path from start-to-finish with the positive of the second LED connected to the negative of the first. Series wiring allows a single driver to be mounted remotely, powering a number of series fittings. Often the most simplest of wiring schemes as each fitting is connected to the next in a daisy chain. It removes the need for a smaller 12 volt driver in each fitting.

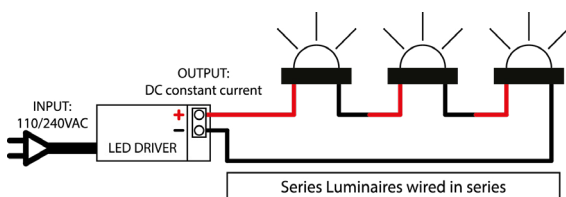

## INTEGRAL DRIVER + TRANSFORMER

In a parallel circuit all the positive connections are tied together and back to the positive output of the LED driver and all the negative connections are tied together and back to the negative output of the driver. The integral driver option allows LuxR fittings to be wired in parallel to existing or new installations where a wire wound or magnetic transformer is being used.

