

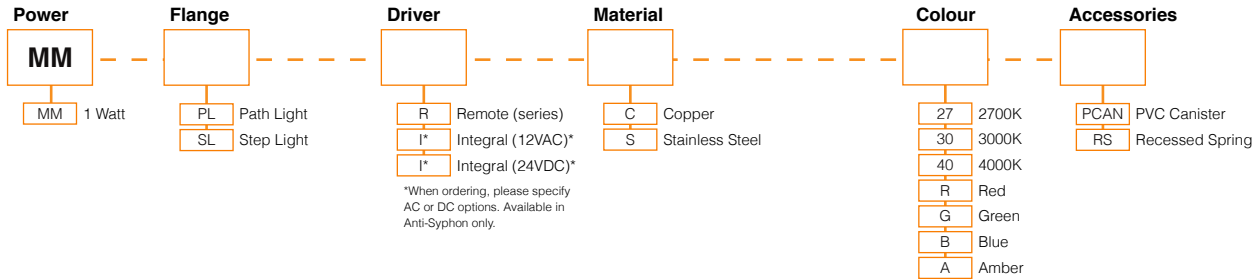

MICRO PATHLIGHT/STEPLIGHT CONFIGURATION

Please fill in appropriate codes into boxes provided



MICRO PATHLIGHT & STEPLIGHT

SPECIFICATIONS:

Power	Up to 1 Watt, (60-360mA)
Ingress Protection Rating	IP68
Cable	H05RN-F 2x 0.75mm
Material	Natural Copper 316 Stainless Steel
Removable Light Engine	Pin Mounted 1W Cree XPG-3 Chip
Colour Temperature	Warm White - 2700K and 3000K Neutral White - 4000K
CRI	90+ CRI
Efficiency	70 lm/w - Delivered from Luminaire with unobstructed beam
Input	60-360mA Constant current (Remote) 12V AC (Integral) 24V DC (Integral)
Warranty	Electronics Warranty 5 Years
Body Warranty	10 years Copper and Stainless Steel
Load Rating	Stainless Steel only 2500kg/5500lbs
LED Life Expectancy	50,000 Hours
B Number	94.05

COPPER IS A SOFT METAL AND IS NOT SUITABLE FOR DRIVE OVER APPLICATIONS

ACCESSORIES

PVC recessed canister
Please refer to the canister spec sheets for more information
www.luxrled.com

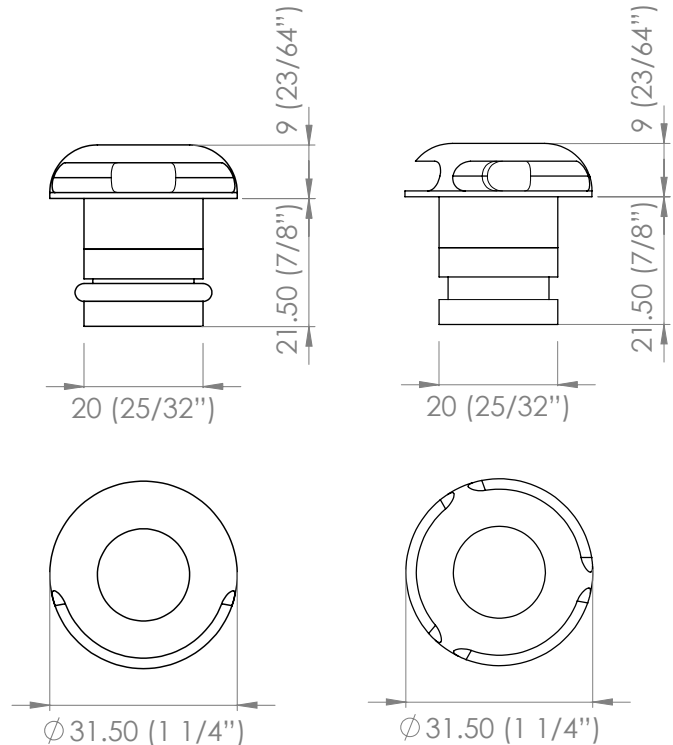
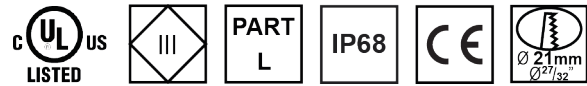

INTEGRAL (12VAC-24VDC) DRIVER HOUSING

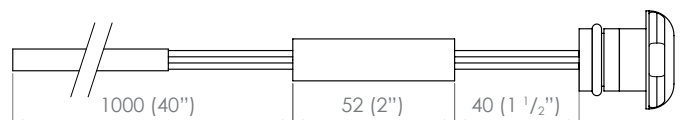

BEAM ANGLES

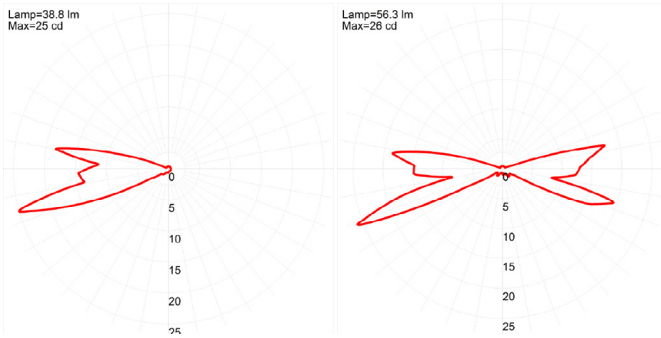

Micro Steplight

Micro Pathlight



RECOMMENDATIONS

Using the PVC mounting canister will make recessed installation of this product simple. Core a hole in an existing wall or cast the conduit in. Once in place, simply push the fitting into the conduit hole. The luminaire will be retained by a silicon "O" ring.

REPLACING COMPONENTS

Firstly remove the luminaire from its recessed location. Unscrew the flange paying close attention to the assembly order or refer to the diagram below. Locate the item that needs to be replaced, it is imperative you replace the component with factory LuxR parts to ensure correct operation of the luminaire. When reassembling make sure all the components are in their correct order to ensure water tightness and correct light output.

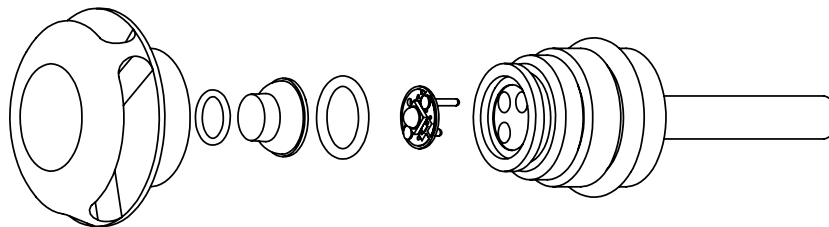

MICRO PATHLIGHT/STEPLIGHT

The Micro luminaire range is powered by a 1 watt LuxR light engine that offers a wide choice of LED colours. The luminaire was developed to meet the challenge of delivering high quality practical accent lighting with maximum energy efficiency and a long, maintenance-free life.

All LuxR luminaires offer a replaceable LED system using Cree LED chips for maximum performance and long life. Precise LED binning by Cree ensure the same colour temperature across all our luminaires which allows LuxR products to be situated close to one another without the fear of colour variance in the colours.

This luminaire is extremely tough, durable and waterproof, making it ideal for installation in public spaces, large-scale projects and residential areas.

REMOTE DRIVER WIRED IN SERIES

Often referred to as series wiring the current in a series circuit follows one path from start-to-finish with the positive of the second LED connected to the negative of the first. Series wiring allows a single driver to be mounted remotely, powering a number of series fittings. Often the most simplest of wiring schemes as each fitting is connected to the next in a daisy chain. It removes the need for a smaller 12 volt driver in each fitting.

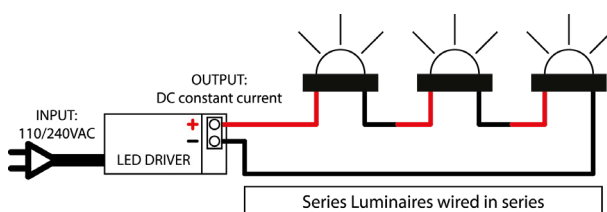

INTEGRAL DRIVER + TRANSFORMER

In a parallel circuit all the positive connections are tied together and back to the positive output of the LED driver and all the negative connections are tied together and back to the negative output of the driver. The integral driver option allows LuxR fittings to be wired in parallel to existing or new installations where a wire wound or magnetic transformer is being used.

